



Mesas en cruz con avance automático  
 Tables croisées à avance automatique  
*Cross slide tables with automatic feed*  
*Kreuztische mit automatischem Vorschub*



# Mesas de Oferta en amarillo.



**200-M**

MOD.	S mm/min	V. 	V. 	HP
204-M	43-86-225	220 380	220	0,06
205-M	43-86-225	220 380	220	0,06

Al hacer el pedido, indicar si es corriente trifásica a 220 ó 380 V. o monofásica a 220 V. y 50 Hz.  
 En cas de commande indiquer le courant désiré: Triphasé 220 V ou 380 V, ou monophasé 220 V et 50 Hz.  
*In your order please indicate whether three phase current, 220 or 380 V, or monophase current, 220 V and 50 Hz, is required*  
*Bei Bestellung ist anzugeben ob Drehstrom, 220 oder 380 V, oder Einphasenstrom, 220 V und 50 Hz, erforderlich.*

Mesas movimiento X  
 Tables mouvement X  
*Tables, motion X*  
*Tische Bewegung X*

**Hasta agotar existencias**





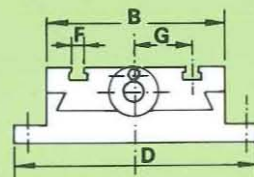
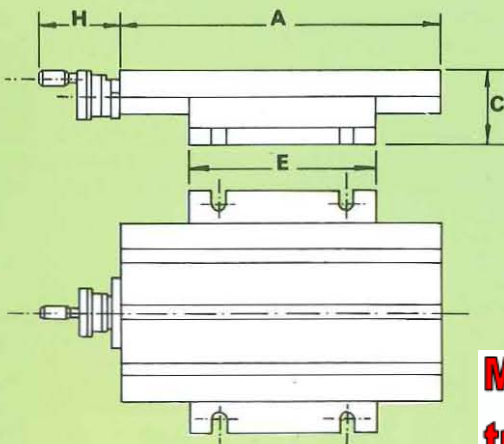



**Mesa 206-x .- 699€.**



Máximo peso admitido en el centro de la mesa.  
 Poids maximum admis au centre de la table.  
*Maximum weight permitted for the centre of the table.*  
 Höchstzulässiges Gewicht im Tischzentrum.

Máxima presión de trabajo en el centro de la mesa.  
 Pression de travail maximum au centre de la table.  
*Maximum working pressure for the centre of the table.*  
 Höchstzulässiger Arbeitsdruck im Tischzentrum.

**Mas información**  
**tno.- 976 470440**

MOD.	A x B mm.	x mm.	C mm.	D mm.	E mm.	 n.º	F mm.	G mm.	H mm.	 mm.	 mm.	 Kg.	 Kg.	
202-x	225x175	120	70	226	160	3	12	72	56	4	0,05	13	55	575
203-x	330x220	220	75	270	170	3	12	72	124	4	0,05	20	105	800
204-x	425x240	270	85	300	250	3	12	72	141	4	0,05	37	270	1000
205-x	600x240	370	85	300	250	3	12	72	141	4	0,05	48	270	1100
<b>206-x</b>	<b>800x240</b>	<b>500</b>	<b>115</b>	<b>340</b>	<b>375</b>	<b>3</b>	<b>12</b>	<b>72</b>	<b>115</b>	<b>4</b>	<b>0,02</b>	<b>82</b>	<b>290</b>	<b>1350</b>

**Mesas en cruz con base fija**  
 Tables croisées à base fixe  
**Cross slide tables with fixed base**  
 Kreuztische mit unbeweglicher Grundplatte

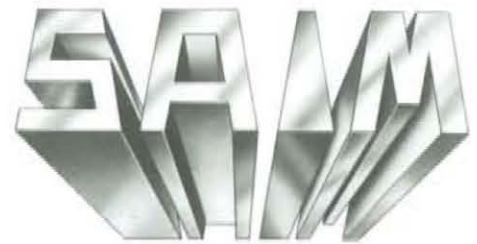

**200**

**Mesas de Oferta en amarillo.**

**Mas información**  
**tno.- 976 470440**



MOD. 202-203-400

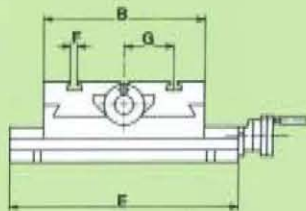

MOD. 204-205-401

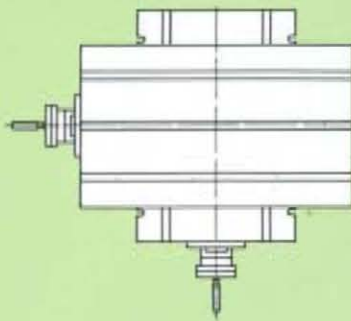
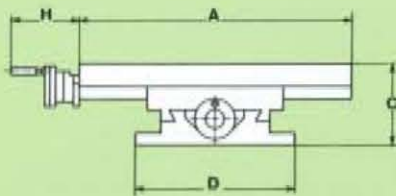

**Hasta agotar existencias**

**Mesa 203.- 499€**  
**Mesa 204.- 599€**  
**Mesa 205.- 650€**

Máximo peso admitido en el centro de la mesa.  
 Poids maximum admis au centre de la table.  
 Maximum weight permitted for the centre of the table.  
 Höchstzulässiges Gewicht im Tischzentrum.



Máxima presión de trabajo en el centro de la mesa.  
 Pression de travail maximum au centre de la table.  
 Maximum working pressure for the centre of the table.  
 Höchstzulässiger Arbeitsdruck im Tischzentrum.



Sin previo aviso podemos introducir variación en las características de las Mesas.  
 Sans avis préalable, nous pouvons introduire une variation dans les caractéristiques des tables.  
 We may introduce variations in the features of the tables without prior notice.  
 Wir behalten uns das Recht vor die Charakteristiken der Tische ohne vorherige Ankuendigung veraendern zu koennen.

MOD.	A x B mm.	X mm.	Y mm.	C mm.	D mm.	E mm.	Nº	F mm.	G mm.	H mm.	mm.	mm.	Kg	Kg.	
202	225 x 175	120	110	108	170	225	3	12	72	56	4	0,05	17	55	575
203	330 x 220	220	130	121	220	275	3	12	72	124	4	0,05	27	105	800
204	425 x 240	270	170	136	275	335	3	12	72	141	4	0,05	45	270	1000
205	600 x 240	370	170	132	275	335	3	12	72	141	4	0,05	60	270	1100
400	225 x 100	135	70	99	100	168	2	8	40	51	1,50	0,025	9	30	270
401	400 x 100	250	80	105	140	160	2	8	40	124	4	0,05	15	30	270



**Mesas en cruz con base fija**  
**Tables croisées à base fixe**  
**Cross slide tables with fixed base**  
**Kreuztische mit unbeweglicher Grundplatte**

**206**

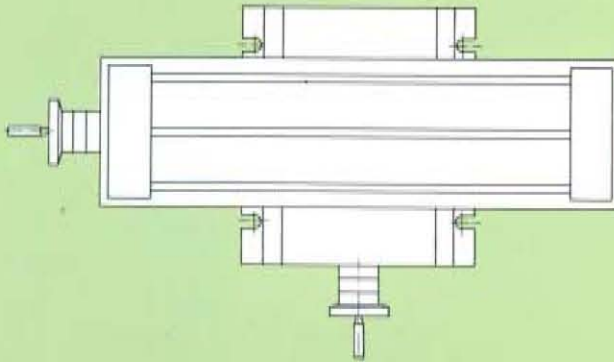
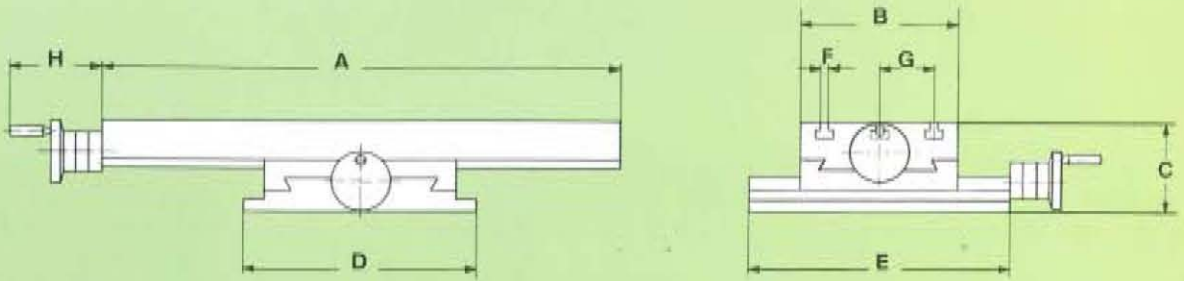

**Mas información**  
**tno.- 976 470440**

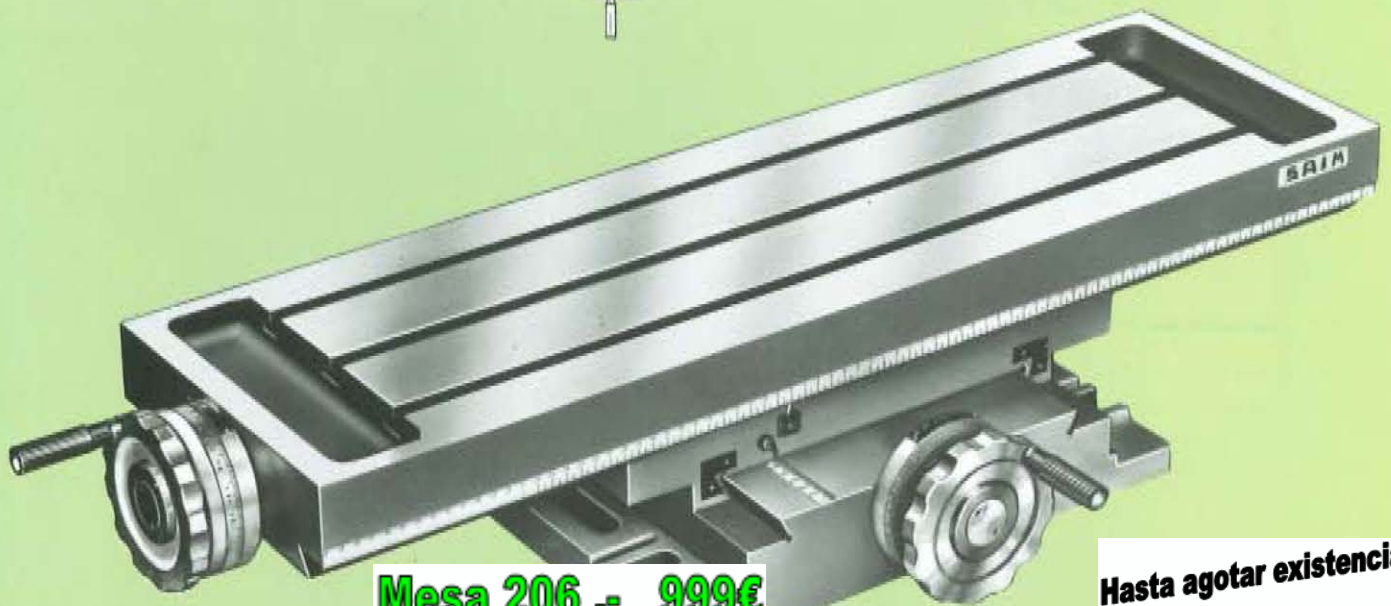

**Mesa 206 .- 999€**

**Mesa 406 .-1.299€**

**Hasta agotar existencias**

**Mesas de Oferta en amarillo.**



Máxima presión de trabajo en el centro de la mesa.  
 Pression de travail maximum au centre de la table.  
 Maximum working pressure for the centre of the table.  
 Höchstzulässiger Arbeitsdruck im Tischzentrum.



Máximo peso admitido en el centro de la mesa.  
 Poids maximum admis au centre de la table.  
 Maximum weight permitted for the centre of the table.  
 Höchstzulässiges Gewicht im Tischzentrum.

MOD.	A x B mm.	X mm.	Y mm.	C mm.	D mm.	E mm.	Nº	F mm.	G mm.	H mm.	mm.	mm.	Kg.	Kg.	
206	800 x 240	500	230	160	375	425	3	12	72	115	4	0,02	105	290	1350
406-E	800 x 315	500	240	168	278	487	3	12	72	115	4	0,02	145	340	1400



**Mesas en cruz con base giratoria**  
**Tables croisées à base tournante**  
**Cross slide tables with swivel base**  
**Kreuztische mit drehbarer Grundplatte**

**300**

**Mas información**  
**tno.- 976 470440**

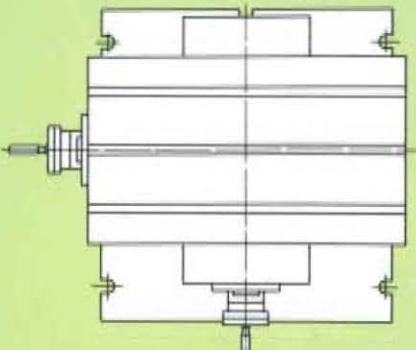
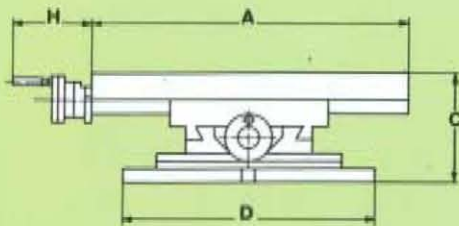
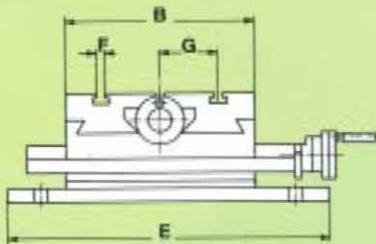

MOD. 302-303



MOD. 304-305-306

**Mesas de Oferta en amarillo.**

Construcción mesa 306 similar a la 206.  
 Table 306: Construction similaire à la table 206.  
 Construction table 306 similar to 206.  
 Bau von Kreuztisch 306 ähnlich Typ 206.

**Mesa 303.- 540€**

**Mesa 304.- 650€**

**Hasta agotar existencias**

Máximo peso admitido en el centro de la mesa.  
 Poids maximum admis au centre de la table.  
 Maximum weight permitted for the centre of the table.  
 Höchstzulässiges Gewicht im Tischzentrum.

Máxima presión de trabajo en el centro de la mesa.  
 Pression de travail maximum au centre de la table.  
 Maximum working pressure for the centre of the table.  
 Höchstzulässiger Arbeitsdruck im Tischzentrum.



MOD.	A x B mm.	X mm.	Y mm.	C mm.	D mm.	E mm.	5 N°	F mm.	G mm.	H mm.	4 mm.	± mm.	Kg.	Kg.	1 mm.
302	225 x 175	120	110	135	183	228	3	12	72	56	4	0,05	21	55	575
303	330 x 220	220	130	142	257	286	3	12	72	124	4	0,05	35	105	800
304	425 x 240	270	170	164	287	347	3	12	72	141	4	0,05	58	270	1000
305	600 x 240	370	170	164	287	347	3	12	72	141	4	0,05	68	270	1100
306	800 x 240	500	230	225	380	425	3	12	72	115	4	0,02	119	290	1350